

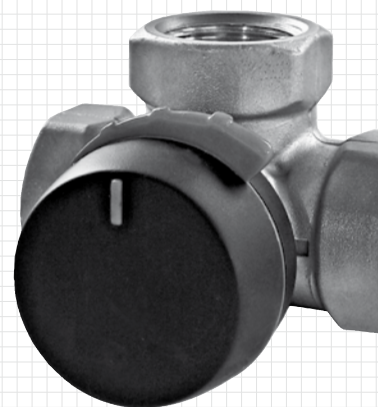

www.esbe.se



SERIES VRG130



NO.1 IN HYDRONIC SYSTEM CONTROL



Series VRG131

Series VRG132

Series VRG133

CE

Pressure Equipment Directive 97/23/EC

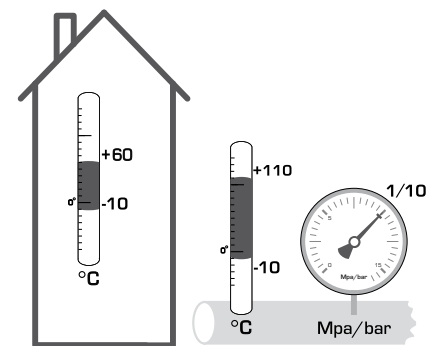
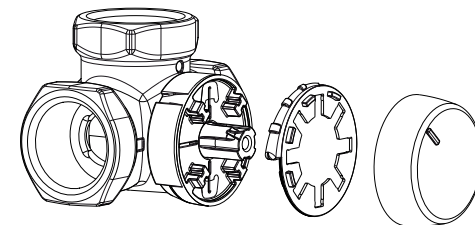

Mtrl.nr. 98 14 02 69 • Ritn.nr. 7045 utg PA1 • Rev. 0705

1a

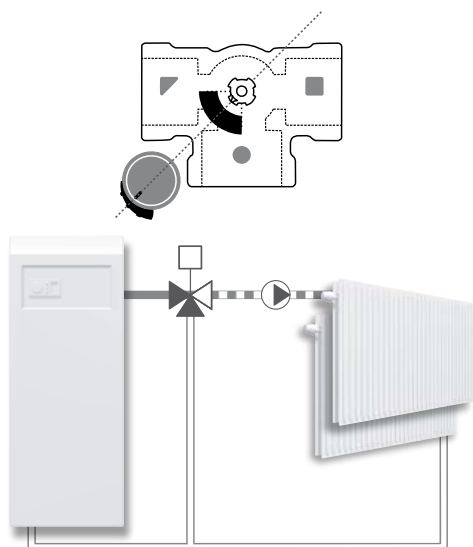

1b

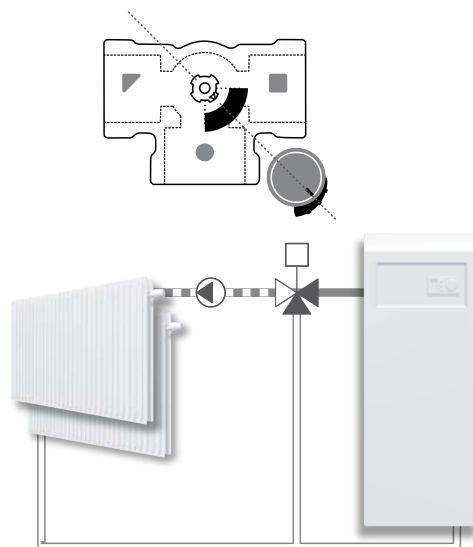

2a

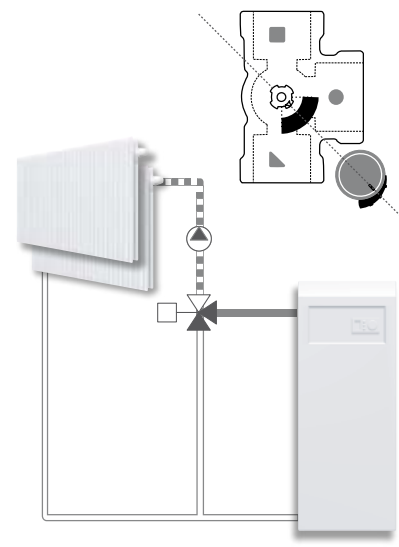

2b

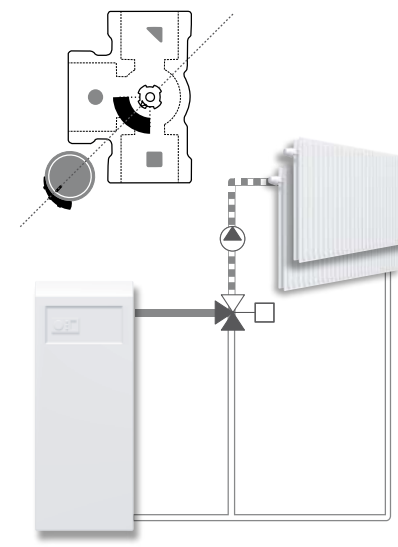

3a

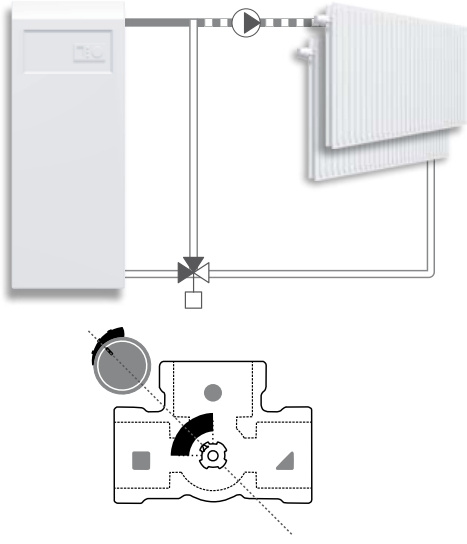

3b

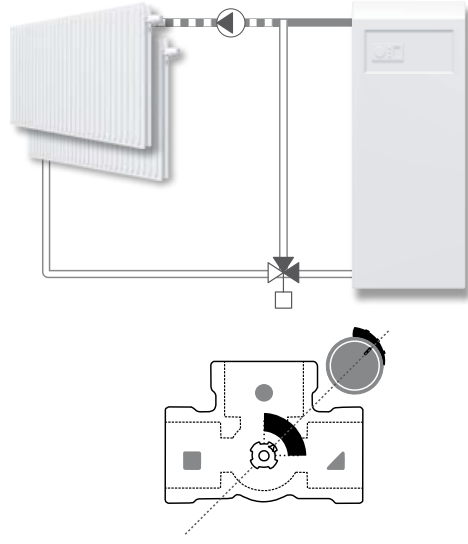

4a

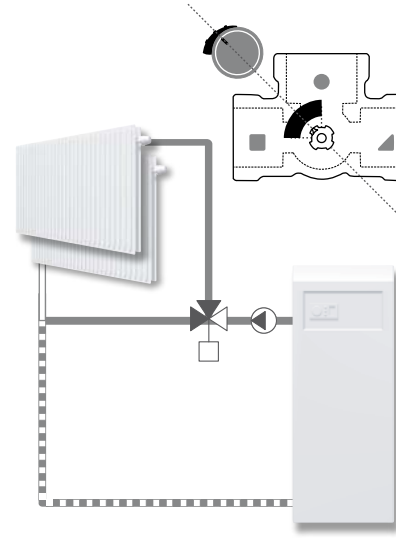

4b

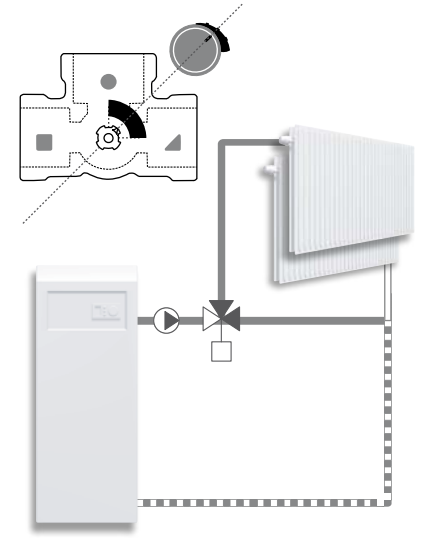

5a

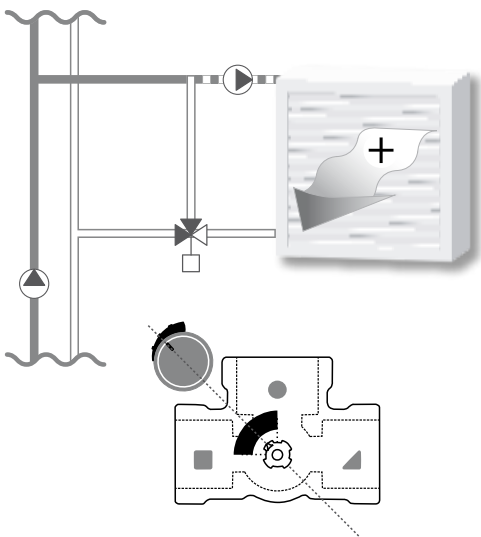

5b

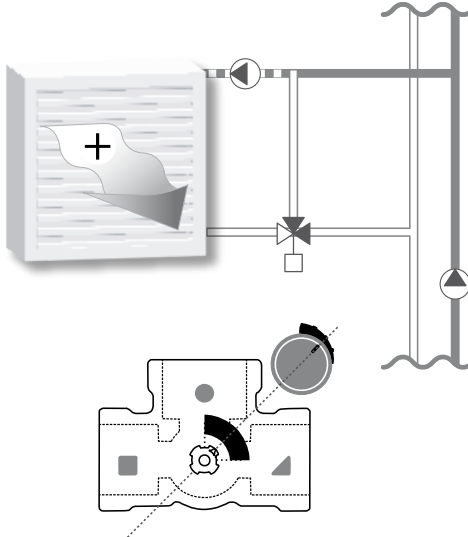

6a

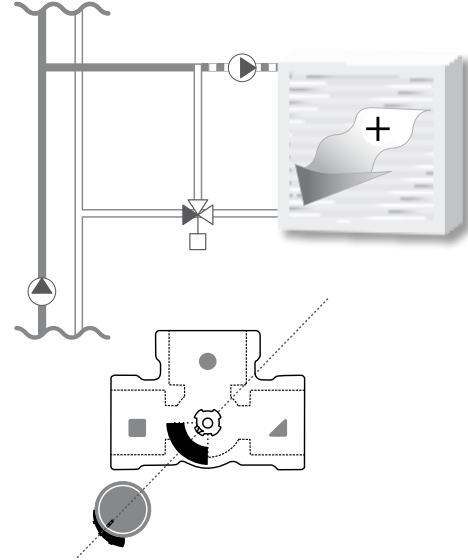

6b

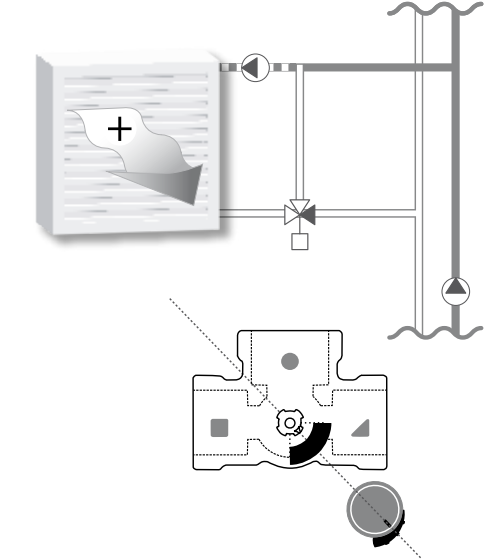

7a

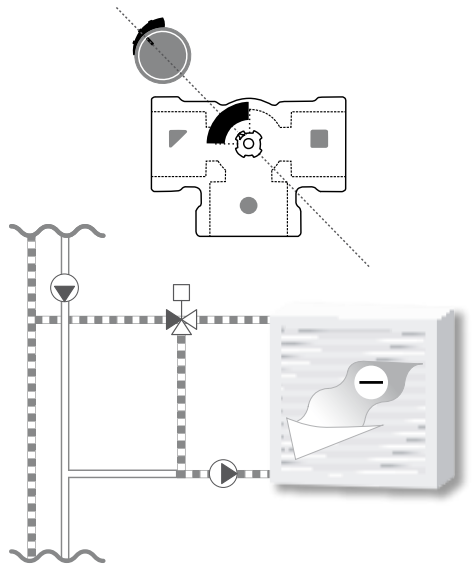

7b

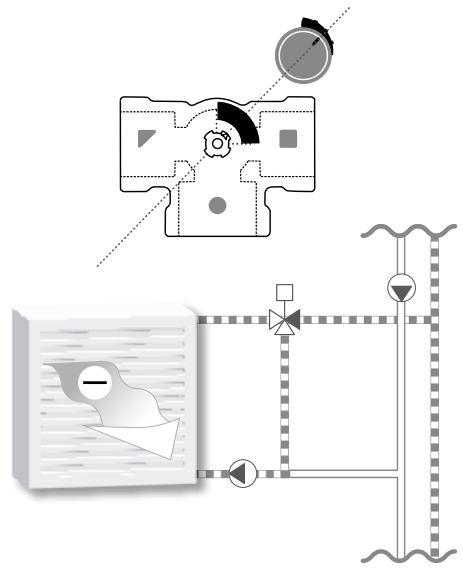

8a

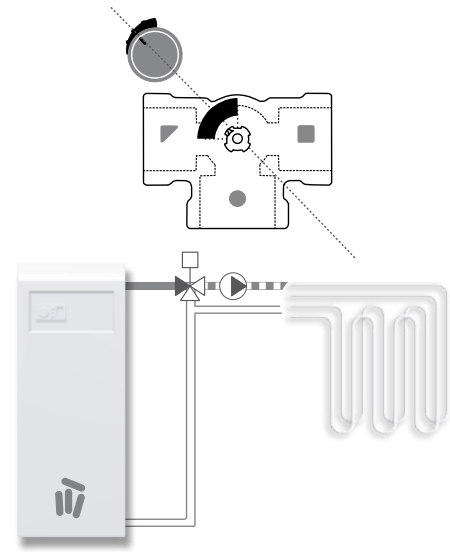

8b

